

Description

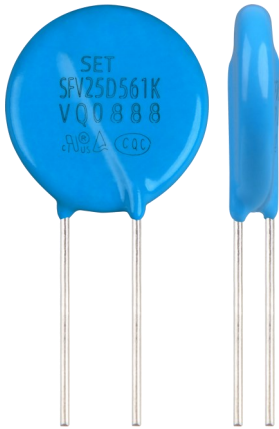

Metal Oxide Varistor (MOV) is a nonlinear resistance component with zinc oxide (ZnO) as its main constituent. The resistance of an MOV is sensitive to changes in the applied voltage. Below the threshold voltage, the MOV exhibits high resistance, allowing only a negligibly small leakage current to flow. Once the threshold voltage is exceeded, the resistance of the MOV drops sharply, enabling the conduction of a large current. This characteristic makes the MOV suitable for detecting and suppressing surge voltage and overvoltage, thereby protecting the circuit from damage caused by excessive voltage.

The Metal Oxide Varistor (MOV) finds wide application in various fields such as photovoltaics, communication, lightning protection, power supply, and power strips. It serves to suppress transient overvoltage and absorb surge energy within the circuit.

SETsafe | SETfuse offers Metal Oxide Varistors (MOV) with maximum peak current ratings ranging from 0.75 kA to 70 kA, and maximum continuous voltage ratings from 14VAC to 750 VAC. Safety certification includes UL, cUL, TUV, and CQC, and complies with RoHS and REACH requirements.

Product Structure

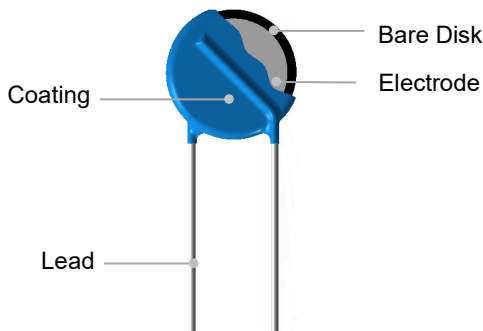

Lead Types

Lead Types	Codes
Straight Lead	A
Outward Crimp Lead	C
Inline Crimp Lead	I
Little Straight Lead	D

Agency Information

Agency	Standards	No.
	UL 1449 4 th Edition	E322662
	CSA C22.2 NO.269.5-17	E322662
	EN IEC 61051-1:2018 EN IEC 61051-2:2021 IEC 61051-2-2:1991 Annex G.8.1 of IEC 62368-1:2023	J 50456266
	GB/T 10193-1997 GB/T 10194-1997 GB 4943.1-2022 IEC 61051-2-1991+Amd1:2009	CQC21001292477

Applications

- Power Supplies
- Home Electrical Appliances
- Industrial Devices
- Surge Protectors
- Telecom Devices

Marking

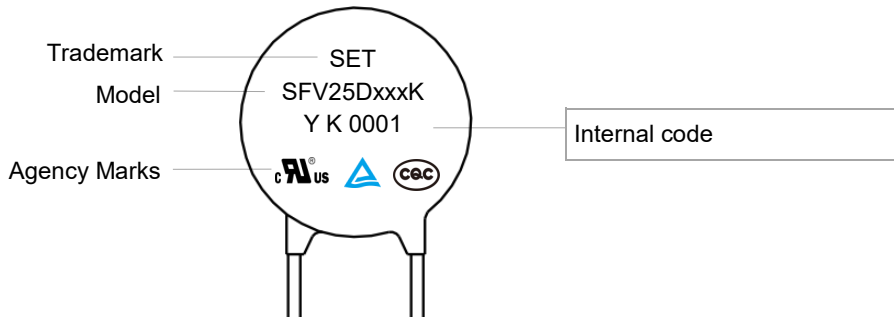

Temp. Derating Curve

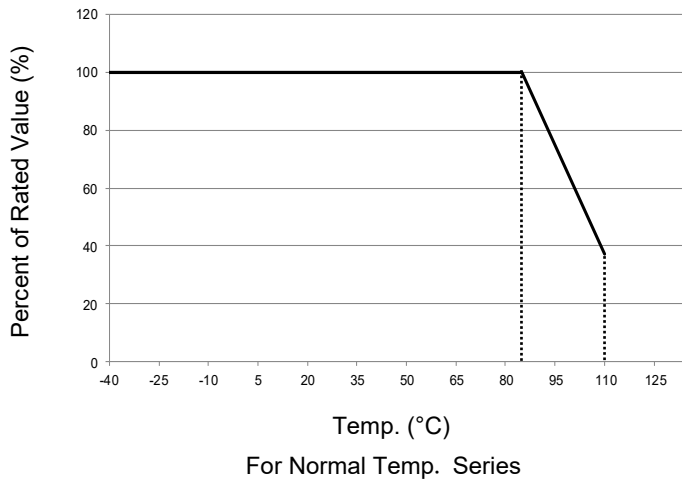

Note:
When ambient Temp. exceeds 85 °C, the peak surge current and energy rating should be reduced as shown in left curve.

General Technical Data

Item	Value	Unit
Operating Temperature	-40 to +85	°C
Storage Temperature	-40 to +125	°C
Voltage Proof	≥2500	V _{ac}
Insulation Resistance	≥100	MΩ

Dimensions (mm)

Model	L (Min.)	H (Max.)	T (Max.)	D (Max.)	d	F	F ₁	A (Max.)
SFV25D220K	20	32	5.5	28	1.20±0.05	10.0±1.0	1.3 ~ 2.9	35
SFV25D270K	20	32	5.8	28	1.20±0.05	10.0±1.0	1.4 ~ 3.1	35
SFV25D330K	20	32	6.1	28	1.20±0.05	10.0±1.0	1.5 ~ 3.3	35
SFV25D390K	20	32	6.4	28	1.20±0.05	10.0±1.0	1.6 ~ 3.5	35
SFV25D470K	20	32	5.6	28	1.20±0.05	10.0±1.0	1.4 ~ 3.1	35
SFV25D560K	20	32	5.8	28	1.20±0.05	10.0±1.0	1.5 ~ 3.3	35
SFV25D680K	20	32	6.1	28	1.20±0.05	10.0±1.0	1.6 ~ 3.6	35
SFV25D820K	20	32	5.4	28	1.20±0.05	10.0±1.0	1.4 ~ 3.0	35
SFV25D101K	20	32	5.6	28	1.20±0.05	10.0±1.0	1.5 ~ 3.2	35
SFV25D121K	20	32	5.8	28	1.20±0.05	10.0±1.0	1.6 ~ 3.4	35
SFV25D151K	20	32	6.1	28	1.20±0.05	10.0±1.0	1.7 ~ 3.7	35
SFV25D181K	20	32	5.4	28	1.20±0.05	10.0±1.0	1.4 ~ 3.3	35
SFV25D201K	20	32	5.5	28	1.20±0.05	10.0±1.0	1.5 ~ 3.4	35
SFV25D221K	20	32	5.6	28	1.20±0.05	10.0±1.0	1.6 ~ 3.5	35
SFV25D241K	20	32	5.7	28	1.20±0.05	10.0±1.0	1.7 ~ 3.6	35
SFV25D271K	20	32	5.9	28	1.20±0.05	10.0±1.0	1.8 ~ 3.8	35
SFV25D301K	20	32	5.7	28	1.20±0.05	10.0±1.0	1.6 ~ 3.6	35
SFV25D331K	20	32	5.9	28	1.20±0.05	10.0±1.0	1.8 ~ 3.8	35
SFV25D361K	20	32	6.5	28	1.20±0.05	10.0±1.0	1.9 ~ 3.9	35
SFV25D391K	20	32	6.0	28	1.20±0.05	10.0±1.0	2.1 ~ 4.1	35
SFV25D431K	20	32	6.2	28	1.20±0.05	10.0±1.0	2.2 ~ 4.2	35
SFV25D471K	20	32	6.4	28	1.20±0.05	10.0±1.0	2.4 ~ 4.4	35
SFV25D511K	20	32	6.6	28	1.20±0.05	10.0±1.0	2.6 ~ 4.6	35
SFV25D561K	20	32	6.8	28	1.20±0.05	10.0±1.0	2.9 ~ 4.9	35
SFV25D621K	20	32	7.0	28	1.20±0.05	10.0±1.0	3.2 ~ 5.2	35
SFV25D681K	20	32	8.5	28	1.20±0.05	10.0±1.0	3.4 ~ 5.4	35
SFV25D751K	20	32	8.9	28	1.20±0.05	10.0±1.0	3.8 ~ 5.8	35
SFV25D821K	20	32	9.4	28	1.20±0.05	10.0±1.0	4.1 ~ 6.1	35
SFV25D911K	20	32	9.9	28	1.20±0.05	10.0±1.0	4.5 ~ 6.5	35
SFV25D102K	20	32	10.5	28	1.20±0.05	10.0±1.0	5.0 ~ 7.0	35
SFV25D112K	20	32	11.1	28	1.20±0.05	10.0±1.0	5.4 ~ 7.4	35
SFV25D122K	20	32	11.7	28	1.20±0.05	10.0±1.0	5.9 ~ 7.9	35

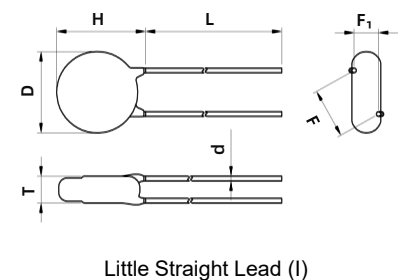
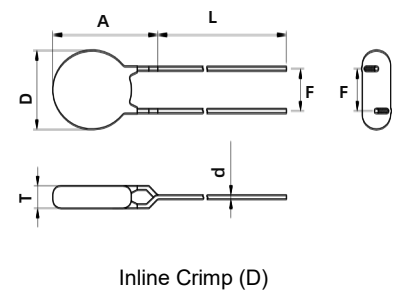
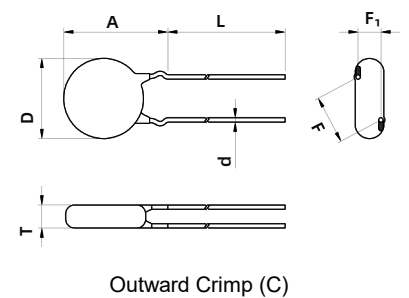
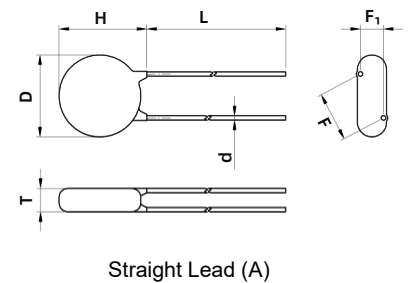
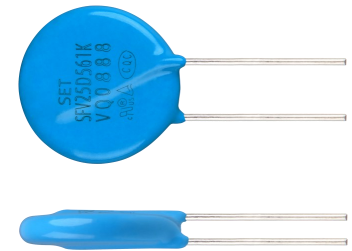

Note:
The above data is for reference only.

Part Numbering System

SFV 25 D 471 - K N K A BUL - 001

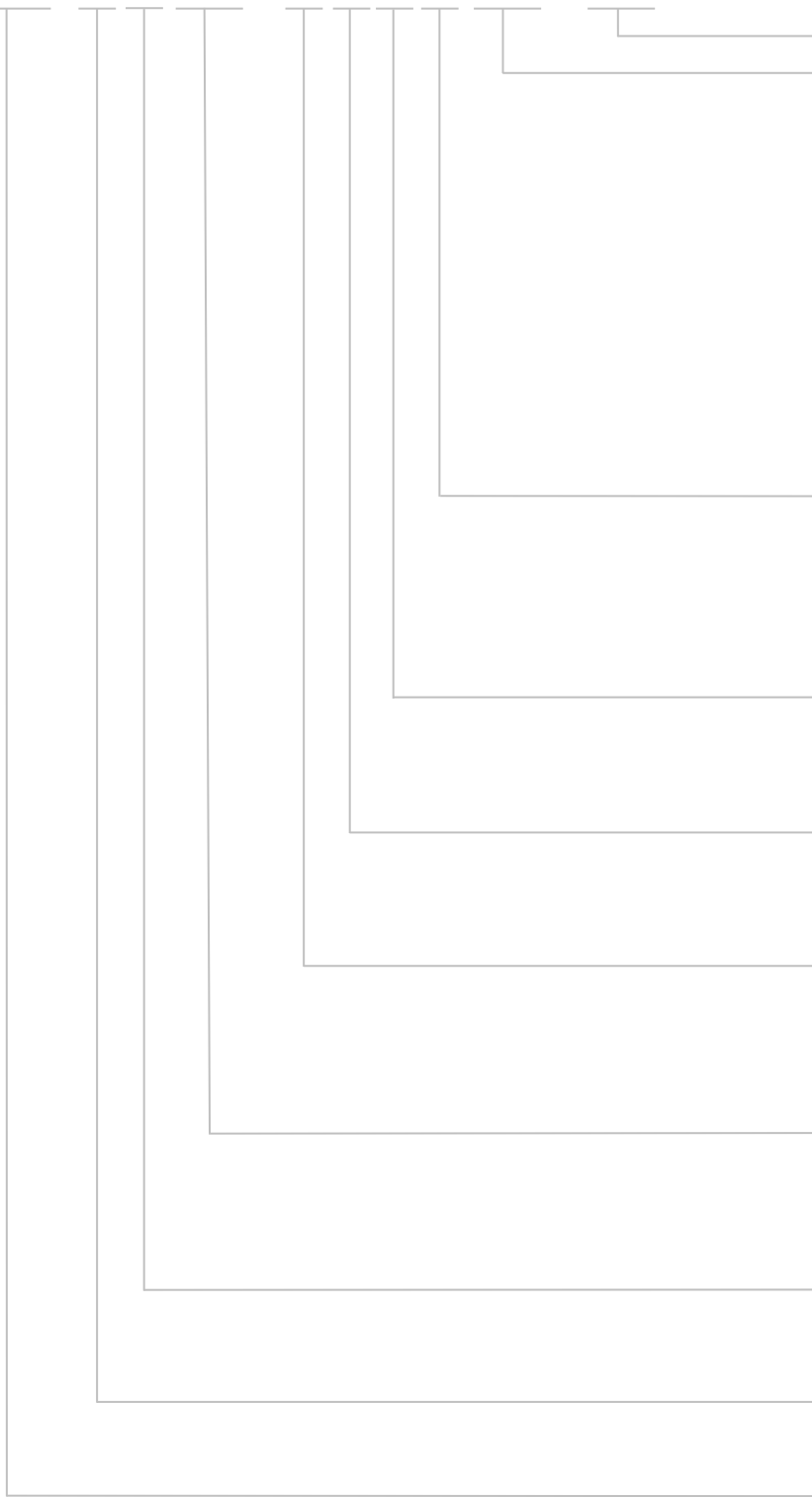

Other Options

***Packaging & Lead Length**

BUL: Bulk + Standard Lead Length (Normal L26)
 C35: Bulk + Cut to 3.5 mm
 (Range:2.5 mm to 6 mm)
 L30: Bulk + Special Lead Length 30 mm
 (28 mm to 32 mm)
 (0/1)AB: Taping + Box (Hole Pitch 12.7 mm)
 (0/1)EB: Taping + Box (Hole Pitch 15.0 mm)
 (0/1)AR: Taping + Reel (Hole Pitch 12.7 mm)
 (0/1)ER: Taping + Reel (Hole Pitch 15.0 mm)
 Note:0/1 Means Product Position
 0: In Middle of Two Holes; 1: Across the Hole

Lead Types

A: Straight Lead
 C: Outward Crimp Lead
 D: Inline Crimp Lead
 I: Little Straight Lead

Surge Level

K: Standard Type

Operating Temp.

N: Epoxy Coating 85 °C

Voltage Tolerance

K: ±10%
 J: ±5%
 S: Special Tolerance

Nominal Varistor Voltage

220: $22 \times 10^0 = 22 \text{ V}$
 471: $47 \times 10^1 = 470 \text{ V}$
 122: $12 \times 10^2 = 1200 \text{ V}$

Disk Shape

D: Round

Bare Disk Dimension

25: 25 mm

Product Category

SETfuse Varistor

Reminder:

Part numbering system in the datasheet is only for selecting correct parameter and product features. Before placing order, please contact us for specifications and use the part number and product code in the specifications to place order to ensure the part is correct. Product code is the unique identification.

Specification

Model	Max. Continuous Operating Voltage		Varistor Voltage @1 mA DC		Clamping Voltage (Max.)		Max. Discharge Current (8/20 μs)		Max. Energy (10/1000 μs)	Typical Capacitance (For reference only) @1 kHz	Agency Information			
	VAC	VDC	Min.	Max.	V _C	I _P	I _n	I _{max}			(J)	(pF)	UL	cUL
	(V)	(V)	(V)	(V)	(V)	(A)	(kA)	(kA)	●	●			○	○
SFV25D220K	14	18	20	24	43	30	1.5	3	25	20500	●	●	○	○
SFV25D270K	17	22	24	31	53	30	1.5	3	30	26500	●	●	○	○
SFV25D330K	20	26	30	36	65	30	1.5	3	35	18000	●	●	○	○
SFV25D390K	25	31	35	43	77	30	1.5	3	40	13500	●	●	○	○
SFV25D470K	30	38	42	52	93	30	3	6	50	11500	●	●	●	●
SFV25D560K	35	45	50	62	110	30	3	6	60	10500	●	●	●	●
SFV25D680K	40	56	61	75	135	30	3	6	70	9050	●	●	●	●
SFV25D820K	50	65	74	90	135	150	10	20	80	7700	●	●	●	●
SFV25D101K	60	85	90	110	165	150	10	20	100	6300	●	●	●	●
SFV25D121K	75	100	108	132	200	150	10	20	120	5200	●	●	●	●
SFV25D151K	95	125	135	165	250	150	10	20	160	4300	●	●	●	●
SFV25D181K	115	150	162	198	300	150	10	20	175	3500	●	●	●	●
SFV25D201K	130	170	180	220	340	150	10	20	190	3200	●	●	●	●
SFV25D221K	140	180	198	242	360	150	10	20	200	2900	●	●	●	●
SFV25D241K	150	200	216	264	395	150	10	20	220	2650	●	●	●	●
SFV25D271K	175	225	243	297	455	150	10	20	255	2400	●	●	●	●
SFV25D301K	190	250	270	330	500	150	10	20	275	2100	●	●	●	●
SFV25D331K	210	275	297	363	550	150	10	20	300	1900	●	●	●	●
SFV25D361K	230	300	324	396	595	150	10	20	330	1750	●	●	●	●
SFV25D391K	250	320	351	429	650	150	10	20	360	1600	●	●	●	●
SFV25D431K	275	350	387	473	710	150	10	20	380	1500	●	●	●	●
SFV25D471K	300	385	423	517	775	150	10	20	400	1400	●	●	●	●
SFV25D511K	320	415	459	561	845	150	10	20	420	1250	●	●	●	●
SFV25D561K	350	460	504	616	925	150	10	20	440	1150	●	●	●	●
SFV25D621K	385	505	558	682	1025	150	10	20	450	1050	●	●	●	●
SFV25D681K	420	560	612	748	1120	150	10	20	460	950	●	●	●	●
SFV25D751K	460	615	675	825	1240	150	10	20	510	850	●	●	●	●
SFV25D821K	510	670	738	902	1355	150	10	20	520	830	●	●	●	●
SFV25D911K	550	745	819	1001	1500	150	10	20	620	730	●	●	●	●
SFV25D102K	625	825	900	1100	1650	150	10	20	690	660	●	●	●	●
SFV25D112K	680	895	990	1210	1815	150	10	20	760	600	●	●	●	●
SFV25D122K	750	990	1080	1320	1980	150	10	20	820	530	●	●	●	●

● : Approved ○ : Unauthorized ● : RoHS & REACH Compliant

Performance Curve (For reference only)

- Max. Peak Current Derating Curves

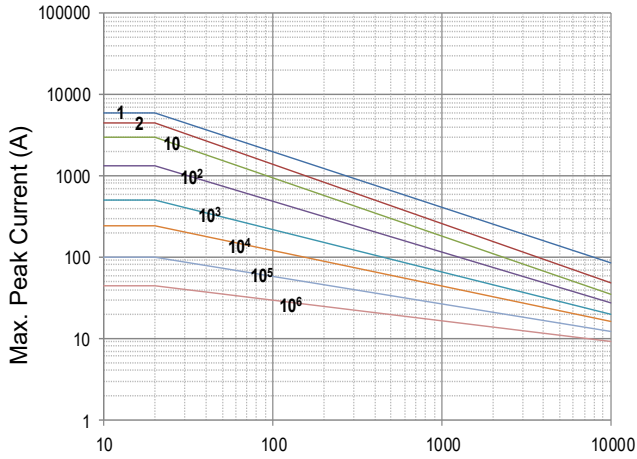

Impulse Duration (µs)
SFV25D220K to SFV25D680K

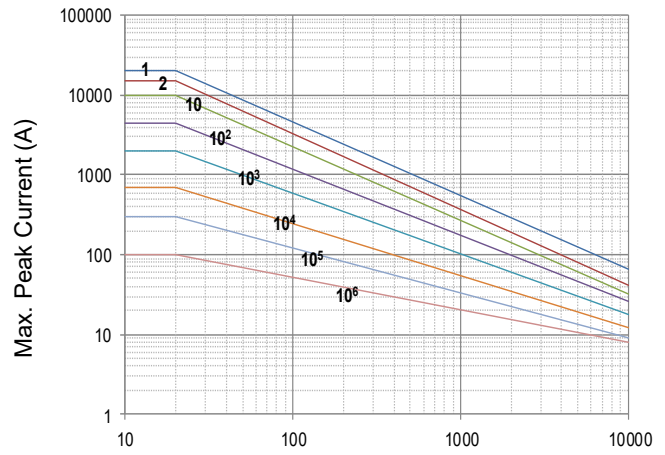

Impulse Duration (µs)
SFV25D820K to SFV25D122K

Note: 1, 2, 10, 10², 10³, 10⁴, 10⁵, 10⁶ Stand for Repetitions.

- Voltage-Current Characteristic Curves

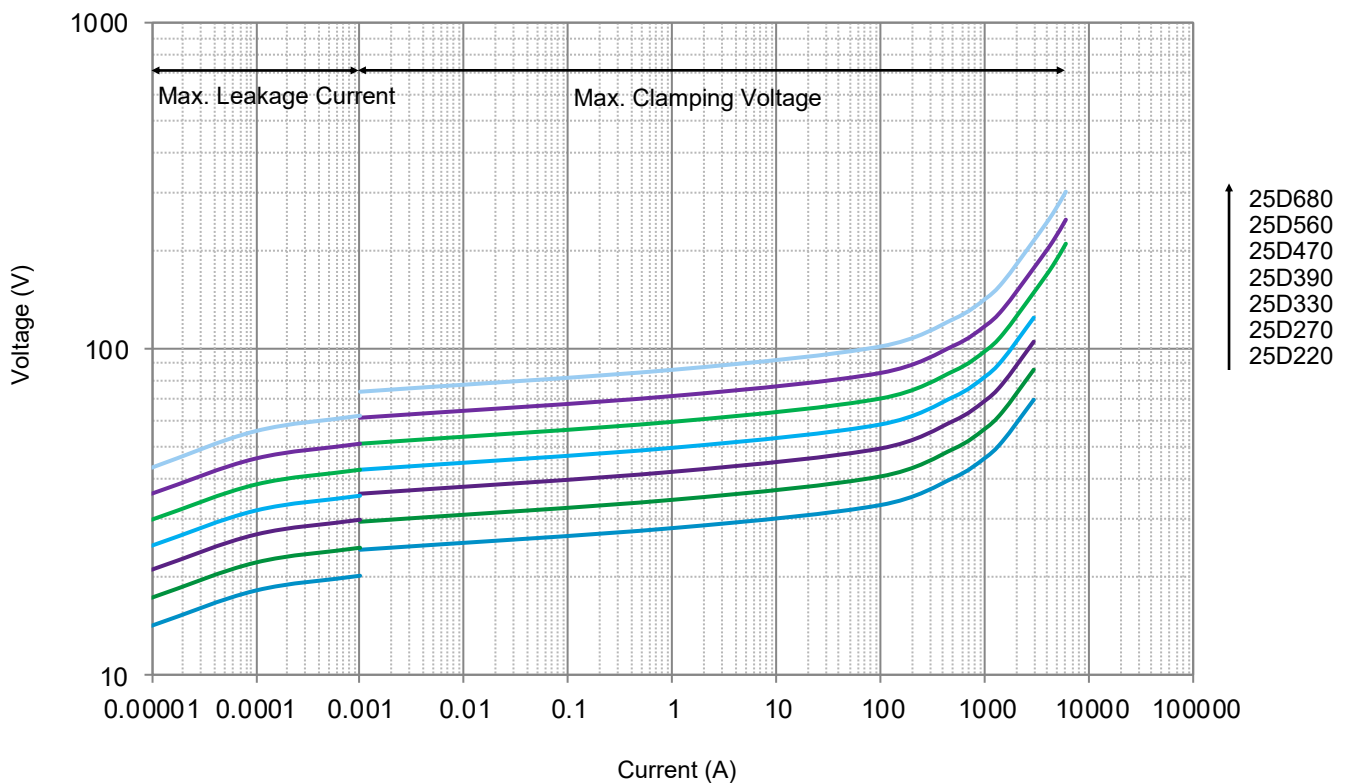

• Voltage-Current Characteristic Curves

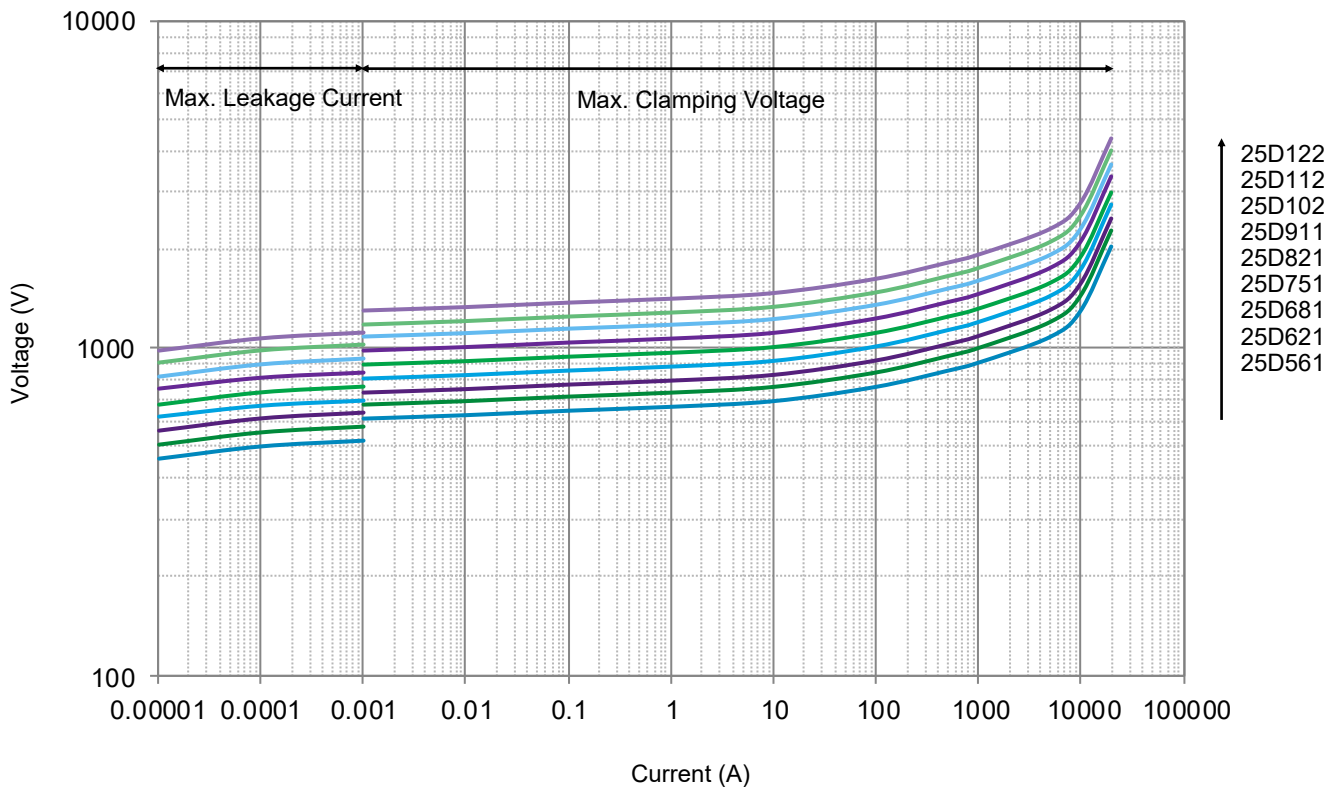
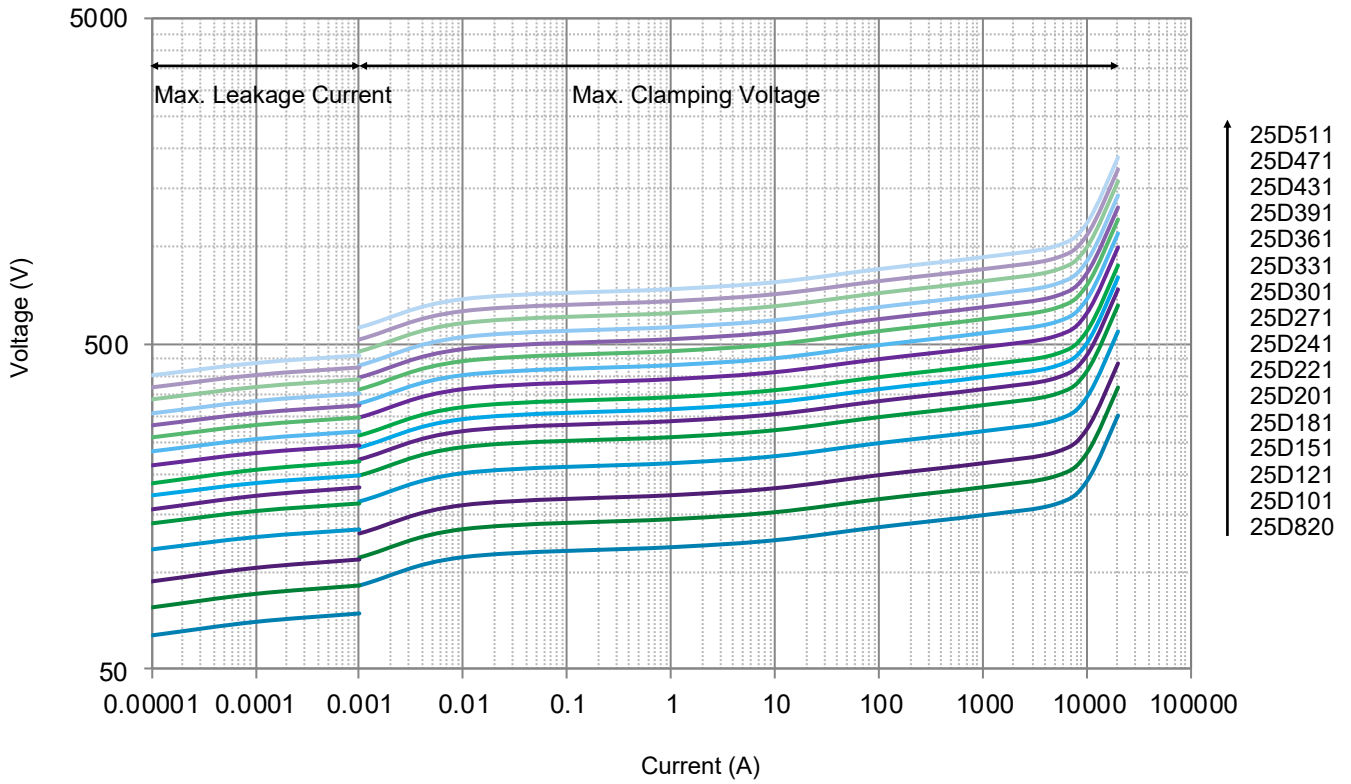

Packaging Information

- Bulk Packaging (Code: BUL)
- Bulk Packaging Quantity & Weight.

Series	Nominal Varistor Voltage	PE Bag	Box	Carton	G. W / Carton (365 × 265 × 245)
	(V)	(PCS)	(PCS)	(PCS)	(kg)±10%
SFV25D Series	220 ~ 621	100	200	1200	5 ~ 15
	681 ~ 122	80	160	960	13 ~ 21

Note:
Other lead length packaging information, please contact SETsafe | SETfuse.

All Dimensions in mm

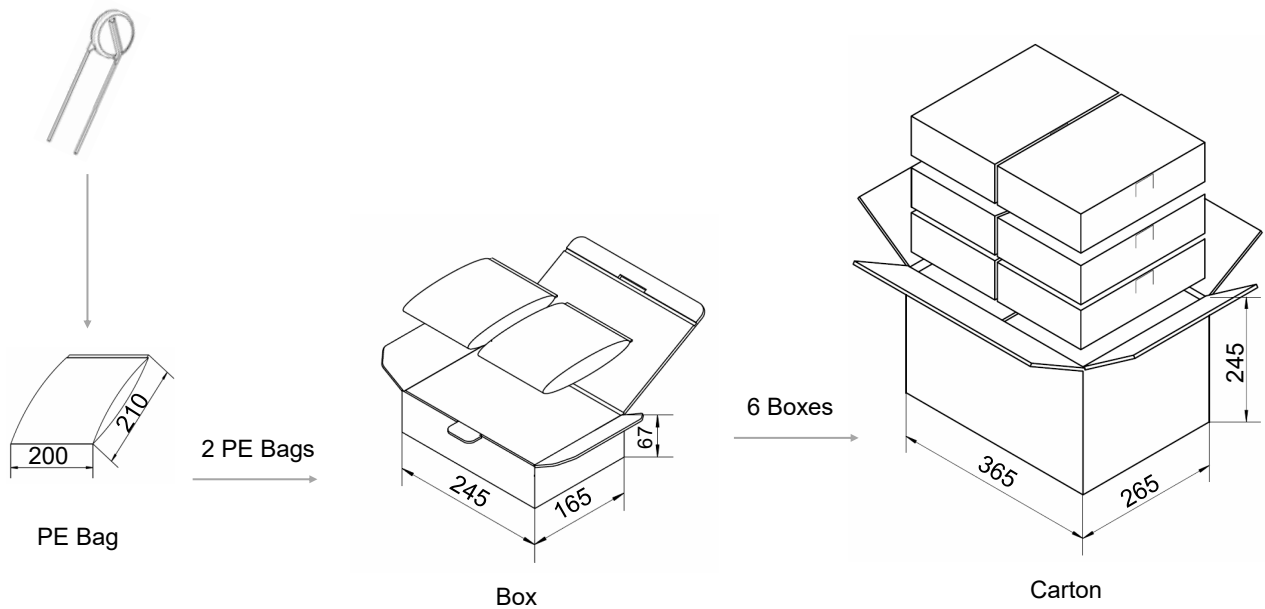

Installation

Mechanical Stress

Do not knock MOV when installing, to avoid mechanical damage.

Soldering Parameters

Wave Soldering Parameters

The wave soldering parameters are for reference only. When MOV is for practice use, some related validation is recommended.

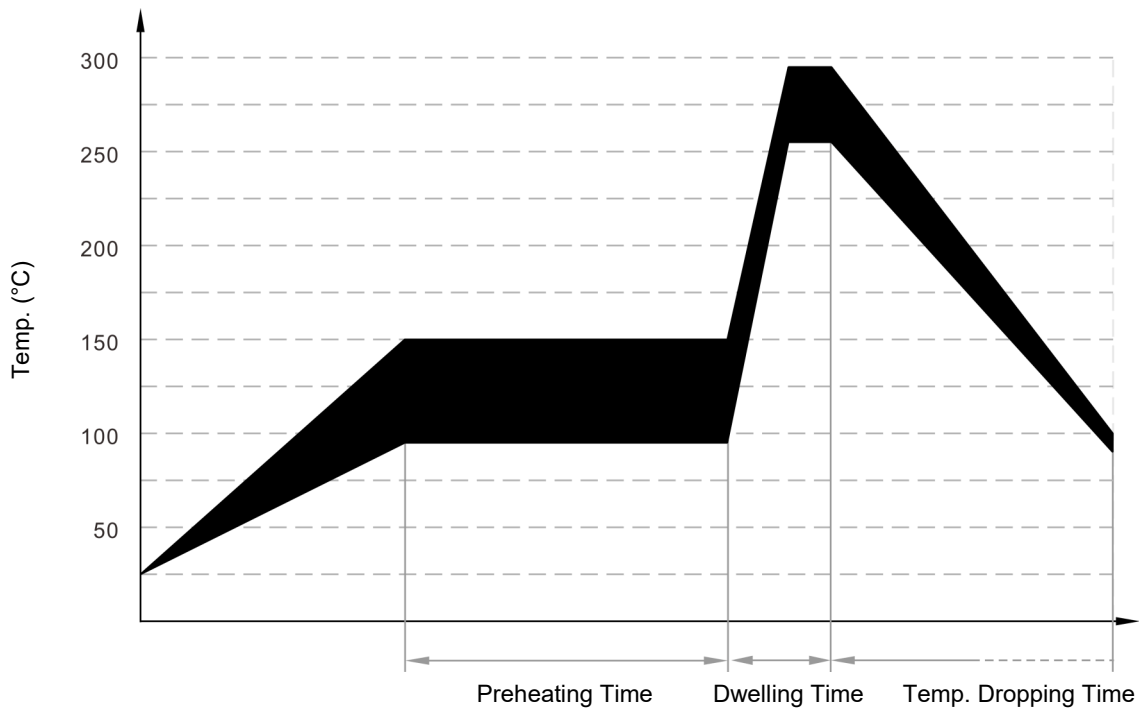

Wave Soldering Curve

Item	Temp. (°C)	Time (s)
Preheating	90 to 150	<150
Dwelling	255 to 290	3 to 10

Recommended Hand-Soldering Parameters

Item	Condition
Temp. of Solder Head	350 °C (max.)
Soldering Time	4 seconds (max.)

Glossary

Item	Description
V_N	Nominal Varistor Voltage Voltage, at specified D.C. current used as a reference point in the component characteristics. — (GB 18802.331) — (IEC 61051-1)
I_L	Leakage Current Measuring at 75% of varistor voltage. — (GB/T 10193) — (IEC 61051-1)
UCT	Upper Category Temp. Max. ambient temp. for which a varistor has been designed to operate continuously. — (GB/T 10193) — (IEC 61051-1)
LCT	Lower Category Temp. Minimum ambient temp. at which a varistor has been designed to operate continuously. — (GB/T 10193) — (IEC 61051-1)
Max. Peak Current	Max. Peak Current Max. current per pulse, which may be passed by a varistor at an ambient temp. of 25 °C, for a given number of pulses. — (GB/T 10193) — (IEC 61051-1)
V_C	Clamping Voltage Peak voltage developed across the varistor terminations under standard atmospheric conditions, when passing an 8/20 μ s class current pulse. — (GB 18802.331) — (IEC 61051-1)
Voltage Proof	Voltage Proof Max. peak voltage, which may be applied under continuous operating conditions between the varistor terminations and any conducting mounting surface (Applicable only to insulated varistors). — (GB/T 10193) — (IEC 61051-1)
C_V	Capacitance Capacitance across the MOV measured at a specified frequency and voltage. — (GB 18802.331) — (IEC 61051-1)
V_{ac}	Max. Continuous a.c. Voltage Max. a.c. r.m.s. voltage of a substantially sinusoidal waveform (less than 5% total harmonic distortion) which can be applied to the component under continuous operating conditions at 25 °C. — (GB/T 10193) — (IEC 61051-1)
V_{dc}	Max. Continuous d.c. Voltage Max. d.c. voltage (with less than 5% ripple) which can be applied to the component under continuous operating conditions at an ambient temp. of 25 °C. — (GB/T 10193) — (IEC 61051-1)
I_{max}	Max. Discharge Current Crest value of a current through the SPD having an 8/20 μ s waveshape and magnitude according to the manufacturers specification. I_{max} is equal to or greater than I_n . — (GB 18802.1) — (IEC 61643-11)



ATTENTION

Usage

1. Varistor must operated in the specified ambient temp.
2. Do not clean the varistor with strong polar solvent such as ketone, esters, benzene and halogenated hydrocarbon.
3. Please do not apply severe vibration, shock or pressure to MOV.
4. Please fix lead wires when bending or cutting. The distance between the bending point and the sealing of MOV shall be greater than 2 mm.

Replacement

If varistor is visually damaged, please replace it.

Storage

1. Storage Temp. Range: (-40 to +125) °C.
2. Relative Humidity : ≤75% RH.
3. Altitude: <2000 m.
4. Do not store the MOV at the high temp., high humidity or corrosive gas environment, to avoid influencing the solder-ability of the lead wires, the product shall be used up within 1 year after receiving the goods.

Environmental Conditions

1. Varistor should neither be exposed to the open air, nor direct sunshine.
2. Varistor should avoid rain, water vapor or other condition of high temp. and high humidity.
3. Varistor should avoid sand dust, salt spray, or other harmful gases.

Max. Typical Capacitance of Varistor

The typical capacitance of varistor is listed in the specifications. Designers may refer to it when designing MOV in high frequency circuit.

Metal Oxide Varistor (MOV) Feature & Model List Overview

Nominal Operating Voltage U_n (V)												Page		Model	Maximum Continuous Operating Voltage U_n (V)	
		AC	DC	0.5	1	1.75	2	3	3.5	6	10	20	70			AC
480V	500V								SFV10D122K(T)	SFV14D122K(T)	SFV20D122K(T)	SFV25D122K(T)	SFV53D122K	750	990	Maximum Continuous Operating Voltage U_n (V)
									SFV10D112K(T)	SFV14D112K(T)	SFV20D112K(T)	SFV25D112K(T)	SFV53D112K	680	895	
415V								SFV10D102K(T)	SFV14D102K(T)	SFV20D102K(T)	SFV25D102K(T)	SFV53D102K	625	825		
380V								SFV10D911K(T)	SFV14D911K(T)	SFV20D911K(T)	SFV25D911K(T)	SFV53D911K	550	745		
				SFV7D821K(T)				SFV10D821K(T)	SFV14D821K(T)	SFV20D821K(T)	SFV25D821K(T)	SFV53D821K	510	670		
100V	250V							SFV10D751K(T)	SFV14D751K(T)	SFV20D751K(T)	SFV25D751K(T)	SFV53D751K	460	615		
								SFV10D681K(T)	SFV14D681K(T)	SFV20D681K(T)	SFV25D681K(T)	SFV53D681K	420	560		
240V								SFV10D621K(T)	SFV14D621K(T)	SFV20D621K(T)	SFV25D621K(T)	SFV53D621K	385	505		
				SFV7D511K(T)				SFV10D561K(T)	SFV14D561K(T)	SFV20D561K(T)	SFV25D561K(T)	SFV53D561K	350	460		
100V	125V							SFV10D511K(T)	SFV14D511K(T)	SFV20D511K(T)	SFV25D511K(T)	SFV53D511K	320	415		
								SFV10D471K(T)	SFV14D471K(T)	SFV20D471K(T)	SFV25D471K(T)	SFV53D471K	300	385		
220V								SFV10D431K(T)	SFV14D431K(T)	SFV20D431K(T)	SFV25D431K(T)	SFV53D431K	275	350		
								SFV10D391K(T)	SFV14D391K(T)	SFV20D391K(T)	SFV25D391K(T)	SFV53D391K	250	320		
100V	120V							SFV10D361K(T)	SFV14D361K(T)	SFV20D361K(T)	SFV25D361K(T)	SFV53D361K	230	300		
								SFV10D331K(T)	SFV14D331K(T)	SFV20D331K(T)	SFV25D331K(T)	SFV53D331K	210	275		
100V	100V							SFV10D301K(T)	SFV14D301K(T)	SFV20D301K(T)	SFV25D301K(T)	SFV53D301K	190	250		
								SFV10D271K(T)	SFV14D271K(T)	SFV20D271K(T)	SFV25D271K(T)	SFV53D271K	175	225		
48V	24V							SFV10D241K(T)	SFV14D241K(T)	SFV20D241K(T)	SFV25D241K(T)	SFV53D241K	150	200		
								SFV10D221K(T)	SFV14D221K(T)	SFV20D221K(T)	SFV25D221K(T)	SFV53D221K	140	180		
12V	12V							SFV10D201K(T)	SFV14D201K(T)	SFV20D201K(T)	SFV25D201K(T)	SFV53D201K	130	170		
								SFV10D181K(T)	SFV14D181K(T)	SFV20D181K(T)	SFV25D181K(T)	SFV53D181K	115	150		
24V	12V							SFV10D151K(T)	SFV14D151K(T)	SFV20D151K(T)	SFV25D151K(T)	SFV53D151K	95	125		
								SFV10D121K(T)	SFV14D121K(T)	SFV20D121K(T)	SFV25D121K(T)	SFV53D121K	75	100		
12V	12V							SFV10D101K(T)	SFV14D101K(T)	SFV20D101K(T)	SFV25D101K(T)	SFV53D101K	60	85		
								SFV10D820K(T)	SFV14D820K(T)	SFV20D820K(T)	SFV25D820K(T)	SFV53D820K	50	65		
12V	12V	SFV7D680K(T)	SFV10D680K(T)		SFV14D680K(T)	SFV20D680K(T)		SFV25D680K(T)					40	56		
		SFV7D560K(T)	SFV10D560K(T)		SFV14D560K(T)	SFV20D560K(T)		SFV25D560K(T)						35	45	
12V	12V	SFV7D470K(T)	SFV10D470K(T)		SFV14D470K(T)	SFV20D470K(T)		SFV25D470K(T)					30	38		
		SFV7D390K(T)	SFV10D390K(T)		SFV14D390K(T)	SFV20D390K(T)		SFV25D390K(T)						25	31	
12V	12V	SFV7D330K(T)	SFV10D330K(T)		SFV14D330K(T)	SFV20D330K(T)		SFV25D330K(T)					20	26		
		SFV7D270K(T)	SFV10D270K(T)		SFV14D270K(T)	SFV20D270K(T)		SFV25D270K(T)						17	22	
12V	12V	SFV7D220K(T)	SFV10D220K(T)		SFV14D220K(T)	SFV20D220K(T)		SFV25D220K(T)					14	18		

Metal Oxide Varistor (MOV) Feature & Model List Overview

Nominal Operating Voltage U_n (V)						Page		Model	Maximum Continuous Operating Voltage U_n (V)	
		1.75	3.5	6	10	20	AC		DC	
480V	500V	○	SFV10D122KM	SFV14D122KM	SFV20D122KM	SFV25D122KM	750	990	Maximum Continuous Operating Voltage U_n (V)	
		○	SFV10D112KM	SFV14D112KM	SFV20D112KM	SFV25D112KM	680	895		
		○	SFV10D102KM	SFV14D102KM	SFV20D102KM	SFV25D102KM	625	825		
		○	SFV10D911KM	SFV14D911KM	SFV20D911KM	SFV25D911KM	550	745		
415V	380V	SFV7D821KM	SFV10D821KM	SFV14D821KM	SFV20D821KM	SFV25D821KM	510	670		
		SFV7D751KM	SFV10D751KM	SFV14D751KM	SFV20D751KM	SFV25D751KM	460	615		
100V	240V	SFV7D681KM	SFV10D681KM	SFV14D681KM	SFV20D681KM	SFV25D681KM	420	560		
		SFV7D621KM	SFV10D621KM	SFV14D621KM	SFV20D621KM	SFV25D621KM	385	505		
100V	250V	SFV7D561KM	SFV10D561KM	SFV14D561KM	SFV20D561KM	SFV25D561KM	350	460		
		SFV7D511KM	SFV10D511KM	SFV14D511KM	SFV20D511KM	SFV25D511KM	320	415		
100V	120V	SFV7D471KM	SFV10D471KM	SFV14D471KM	SFV20D471KM	SFV25D471KM	300	385		
		SFV7D431KM	SFV10D431KM	SFV14D431KM	SFV20D431KM	SFV25D431KM	275	350		
100V	125V	SFV7D391KM	SFV10D391KM	SFV14D391KM	SFV20D391KM	SFV25D391KM	250	320		
		SFV7D361KM	SFV10D361KM	SFV14D361KM	SFV20D361KM	SFV25D361KM	230	300		
100V	125V	SFV7D331KM	SFV10D331KM	SFV14D331KM	SFV20D331KM	SFV25D331KM	210	275		
		SFV7D301KM	SFV10D301KM	SFV14D301KM	SFV20D301KM	SFV25D301KM	190	250		
48V	24V	SFV7D271KM	SFV10D271KM	SFV14D271KM	SFV20D271KM	SFV25D271KM	175	225		
		SFV7D241KM	SFV10D241KM	SFV14D241KM	SFV20D241KM	SFV25D241KM	150	200		
12V	12V	SFV7D221KM	SFV10D221KM	SFV14D221KM	SFV20D221KM	SFV25D221KM	140	180		
		SFV7D201KM	SFV10D201KM	SFV14D201KM	SFV20D201KM	SFV25D201KM	130	170		
12V	12V	SFV7D181KM	SFV10D181KM	SFV14D181KM	SFV20D181KM	SFV25D181KM	115	150		
		SFV7D151KM	SFV10D151KM	SFV14D151KM	SFV20D151KM	SFV25D151KM	95	125		
12V	12V	SFV7D121KM	SFV10D121KM	SFV14D121KM	SFV20D121KM	SFV25D121KM	75	100		
		SFV7D101KM	SFV10D101KM	SFV14D101KM	SFV20D101KM	SFV25D101KM	60	85		
12V	12V	SFV7D820KM	SFV10D820KM	SFV14D820KM	SFV20D820KM	SFV25D820KM	50	65		
		○	○	SFV25D680KM	○	○	40	56		
12V	12V	○	○	SFV25D560KM	○	○	35	45		
		○	○	SFV25D470KM	○	○	30	38		
12V	12V	○	○	○	○	○	25	31		
		○	○	○	○	○	20	26		
12V	12V	○	○	○	○	○	17	22		
		○	○	○	○	○	14	18		
AC	DC	1.75	3.5	6	10	20	AC	DC		

Metal Oxide Varistor (MOV) Feature & Model List Overview

Nominal Operating Voltage U_n (V)		Model											Page	
		2	3	5	6	8	10	15	20	25	40	AC	DC	
480V	500V	○	○	○	○	○	○	SFV20S122K	○	SFV25S122K	SFV34S122K	750	990	
		○	○	○	○	○	○	SFV20S112K	○	SFV25S112K	SFV34S112K	680	895	
415V	500V	○	○	○	○	○	○	SFV20S102K	○	SFV25S102K	SFV34S102K	625	825	
		○	○	○	○	○	○	SFV20S911K	○	SFV25S911K	SFV34S911K	550	745	
380V	500V	○	○	SFV10S821K	○	○	○	SFV15S821K	○	SFV25S821K	SFV34S821K	510	670	
		○	○	SFV10S751K	○	○	○	SFV15S751K	○	SFV25S751K	SFV34S751K	460	615	
100V	-	○	○	SFV10S681K	○	○	○	SFV15S681K	SFV20S681K	○	SFV25S681K	SFV34S681K	420	560
		○	○	SFV10S621K	○	○	○	SFV15S621K	SFV20S621K	○	SFV25S621K	SFV34S621K	385	505
240V	-	○	○	SFV10S561K	○	○	○	SFV15S561K	SFV20S561K	○	SFV25S561K	SFV34S561K	350	460
		○	○	SFV10S511K	○	○	○	SFV15S511K	SFV20S511K	○	SFV25S511K	SFV34S511K	320	415
100V	250V	○	○	SFV10S471K	○	○	○	SFV15S471K	SFV20S471K	○	SFV25S471K	SFV34S471K	300	385
		○	○	SFV10S431K	○	○	○	SFV15S431K	SFV20S431K	○	SFV25S431K	SFV34S431K	275	350
220V	250V	○	○	SFV10S391K	○	○	○	SFV15S391K	SFV20S391K	○	SFV25S391K	SFV34S391K	250	320
		○	○	SFV10S361K	○	○	○	SFV15S361K	SFV20S361K	○	SFV25S361K	SFV34S361K	230	300
100V	-	○	○	SFV10S331K	○	○	○	SFV15S331K	SFV20S331K	○	SFV25S331K	SFV34S331K	210	275
		○	○	SFV10S301K	○	○	○	SFV15S301K	SFV20S301K	○	SFV25S301K	SFV34S301K	190	250
120V	-	○	○	SFV10S271K	○	○	○	SFV15S271K	SFV20S271K	○	SFV25S271K	SFV34S271K	175	225
		○	○	SFV10S241K	○	○	○	SFV15S241K	SFV20S241K	○	SFV25S241K	SFV34S241K	150	200
100V	125V	○	○	SFV10S221K	○	○	○	SFV15S221K	SFV20S221K	○	SFV25S221K	SFV34S221K	140	180
		○	○	SFV10S201K	○	○	○	SFV15S201K	SFV20S201K	○	SFV25S201K	SFV34S201K	130	170
48V	-	○	○	SFV10S181K	○	○	○	SFV15S181K	SFV20S181K	○	SFV25S181K	SFV34S181K	115	150
		○	○	SFV10S151K	○	○	○	SFV15S151K	SFV20S151K	○	SFV25S151K	SFV34S151K	95	125
24V	-	○	SFV10S121K	○	○	○	○	SFV15S121K	SFV20S121K	○	SFV25S121K	SFV34S121K	75	100
		○	SFV10S101K	○	○	○	○	SFV15S101K	SFV20S101K	○	SFV25S101K	SFV34S101K	60	85
12V	-	○	SFV10S820K	○	○	○	○	SFV15S820K	SFV20S820K	○	SFV25S820K	SFV34S820K	50	65
		SFV10S680K	SFV15S680K	SFV20S680K	○	○	○	SFV25S680K	○	SFV34S680K	○	○	40	56
12V	-	SFV10S560K	SFV15S560K	SFV20S560K	○	○	SFV25S560K	○	SFV34S560K	○	○	35	45	
		SFV10S470K	SFV15S470K	SFV20S470K	○	○	SFV25S470K	○	SFV34S470K	○	○	30	38	
12V	-	SFV10S390K	SFV15S390K SFV20S390K	○	○	○	SFV25S390K	○	○	○	○	25	31	
		SFV10S330K	SFV15S330K SFV20S330K	○	○	○	SFV25S330K	○	○	○	○	20	26	
12V	-	SFV10S270K	SFV15S270K SFV20S270K	○	○	SFV25S270K	○	○	○	○	○	17	22	
		SFV10S220K	SFV15S220K SFV20S220K SFV25S220K	○	○	○	○	○	○	○	○	14	18	